



ECO-SUPPORT® ES-SERIES

JOLANI DISTRIBUTION INC.

9063 Milton Avenue, Montreal-West, Quebec, H4X 2H1
Tel 514-381-0098

E-Mail: info@jolanidistributioninc.com



ECO-SUPPORT®
INTERNATIONAL

TECHNICAL SPECIFICATIONS

| | |
|--------------------------------|---|
| Material | Recycled Polypropylene |
| Height range | 25 mm to 156 mm |
| Compressive Strength | 10 KN |
| Base Diameter | 200 mm |
| Spacer Tab Height | 10 mm |
| Space Tab Thickness | 3 mm |
| Biological/Chemical Resistance | Unaffected by molds and algae Alkali and bitumen |

PEDESTAL ASSEMBLY

PADS & TOOL INCLUDED

No need to make any other purchases: everything you need will be included.

ADJUSTABLE HEIGHT

Ranging from 25-230mm in height, any project you need a pedestal for, there is a ES-H Series pedestal to meet its need.

ECO POLYPROPYLENE MATERIAL

Not only economical, but also environmental! Strong and good for almost any weather it comes across, this pedestal will stand the test of time.

STRONG SUPPORT

Each pedestal supports from 300-800 kgs and up to 2 tons per SQM. Pavers, tiles, extra supports such as the 6060G Secure Step® and anything else you need to make your project safe and beautiful.

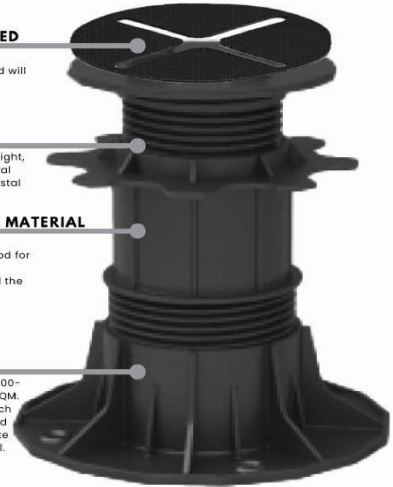

ES-SERIES



ES1 25-30 mm



ES2 30-45 mm



ES3 45-80 mm



ES4 76-156 mm



ES5 150-230 mm

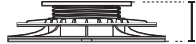

25-30 mm

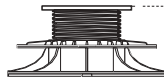

30-45 mm

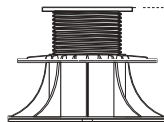

45-80 mm



76-156 mm

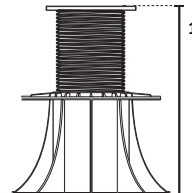

150-230mm



ECO-SUPPORT[®]
INTERNATIONAL

PRODUCT INFORMATION

| Model | Diameter Of base | Heights | Load capacity Per piece (kg) | Per Carton | Applicable temperature |
|--|------------------|------------|------------------------------|------------|------------------------|
|  ES-1 | ∅200mm | 25-30 mm | 300KG | 24 PCS | -30° to 60° |
|  ES-2 | ∅200mm | 30-45 mm | 300KG | 24 PCS | -30° to 60° |
|  ES-3 | ∅200mm | 45-80 mm | 500KG | 24 PCS | -30° to 60° |
|  ES-4 | ∅200mm | 76-156 mm | 600KG | 24 PCS | -30° to 60° |
|  ES-5 | ∅200mm | 150-230 mm | 600KG | 24 PCS | -30° to 60° |



ECO-SUPPORT[®]
INTERNATIONAL

ECO-SUPPORT® PEDESTAL SYSTEM

Eco support gives a flexible and reasonable answer to support raised pavers. It gives a cavity to cover services, improves heat and sound protection, and help in quick drainage, while permitting waterproofing and services to remain accessible.

Ecosupport provides a height and slope customizable platform framework for paver support designed to lessen material, development and lifecycle costs.

It takes special care of an extensive variety of level requirements, from 25mm to 230mm utilizing three primary parts top, extender and base.



Easy and precise slope correction up to 5%



Concealing technical equipment



Quick and easy installation



A system supporting heavy loads



Presence of open joints avoiding all risks of cracking as compared to closed joints. Water evacuation made easier

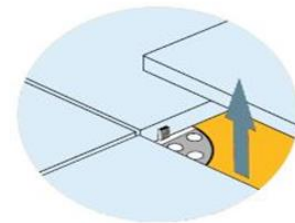

Easy access to the waterproofing membrane or substructure

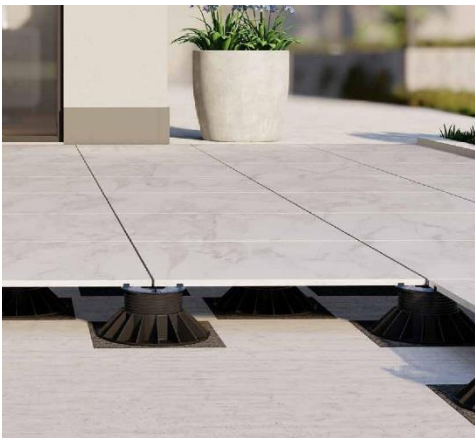

ECO-SUPPORT®
INTERNATIONAL

ECO-SUPPORT FEATURES

FLEXIBLE HEAD



Self-leveling head
Provides slope
correction
up to 5%.

SHIM 3mm



Rubber Shim 3mm
reduces vibrations
and noise Included.

KEY



Adjustment tool
For height
regulation Included.

TABS 3.5mm



Spacer Tab 3.5mm
For easy drainage
Included.

PROJECTS



JOLANI DISTRIBUTION INC.

9063 Milton Avenue, Montreal-West, Quebec, H4X 2H1
Tel 514-381-0098

E-Mail: info@jolanidistributioninc.com



ECO-SUPPORT[®]
INTERNATIONAL